

# ORNAMENTAL STEEL FENCE CATALOG



[info@papa6productions.com](mailto:info@papa6productions.com)



Dallas - Ft. Worth, Texas



[www.Papa6Productions.com](http://www.Papa6Productions.com)



**SPECIAL HIGH SECURITY FENCES USED FOR INDUSTRIAL ZONES, MILITARY AREAS ...**



**USED FOR HOSPITALS, POOLS, SHOPPING MALLS, PUBLIC AREAS...**



**RESIDENTIAL & COMMERCIAL FENCE**



## Industrial, Commercial & Residential Ornamental Steel Fencing & Railing

**Description:** Our Ornamental Steel fences are made from high-quality steel sourced from Vietnam. Its dominant style is simple, functional, and sturdy. Designs range from simple to more decorative & custom applications. Industrial, Commercial, and Residential applications are available.

**Surface treatment:** The product is surface treated on a closed, automatic powder coating line with the following surface requirements:

- 10 year limited warranty
- Passing 1500hr neutral salt spray test under ASTM B117 standard
- Multi protective layer: Zinc galvanized, Nanoceramic, Primer coating, Finishing coating
- Lead-free & UV Resistant

**Available Specifications:**

- **Panel:** 4' - 10' width, 4' - 10' height
- **Picket:** 1/2" - 1", 14GA-20GA
- **Rail:** 1" - 2", 12GA-16GA
- **Post:** 2"x2" - 4"x4", 12GA-18GA; 5' - 12' height
- **Fence Head Options:** Flat, formed tube, detachable spearhead, or complex.
- **Railing Head Options:** Flat
- **Custom Specifications available for project specific needs**

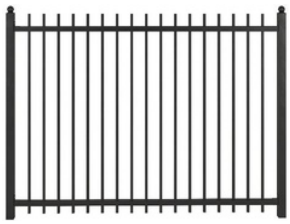

P6SF01

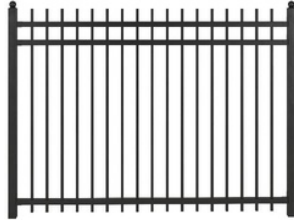

P6SF02

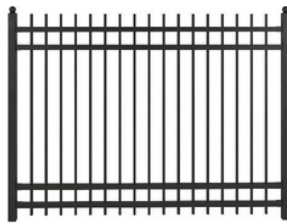

P6SF03

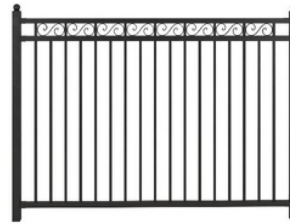

P6SF15



P6SF17



P6SF18

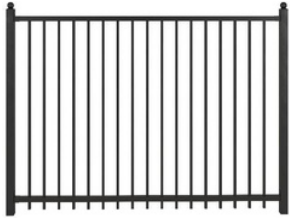

P6SF04



P6SF05

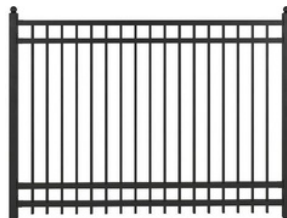

P6SF06



P6SF19

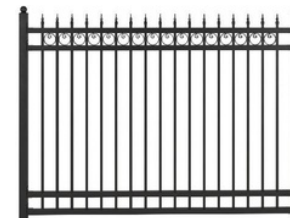

P6SF20

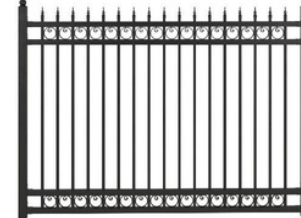

P6SF21

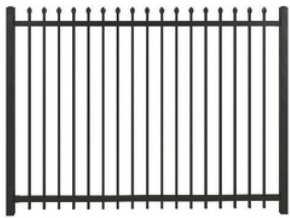

P6SF07

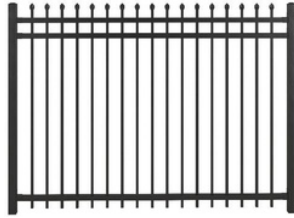

P6SF08

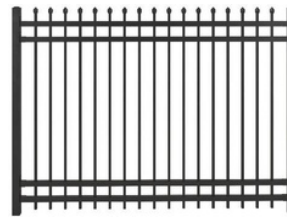

P6SF09

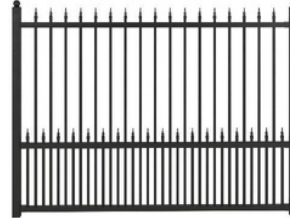

P6SF22



P6SF23

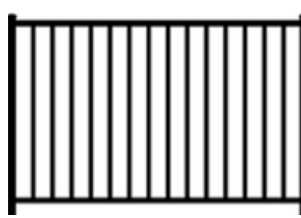

P6SF24

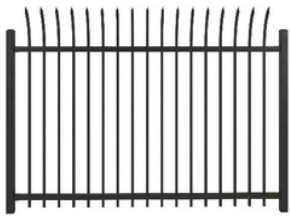

P6SF10

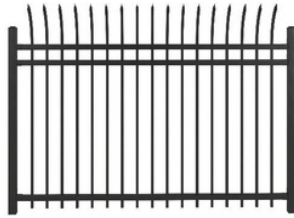

P6SF11

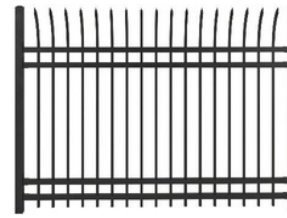

P6SF12



P6SF13



P6SF14



P6SF15



# CONNECTION METHOD

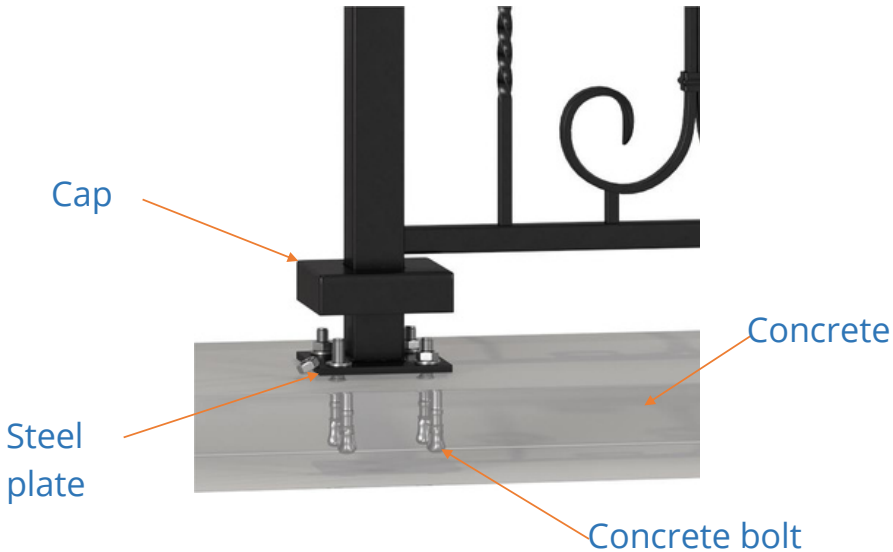

# CUSTOM RAILING PRODUCTS

**Notice:** Railing styles and sizes are designed in accordance with safety standards and fitting for architecture of specific project as investors' requirements.



P6LC01



P6LC02



P6LC03



P6LC04

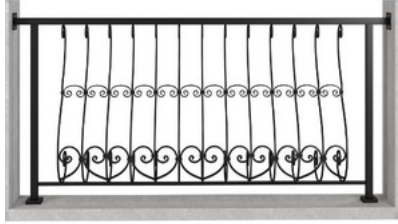

P6LC05

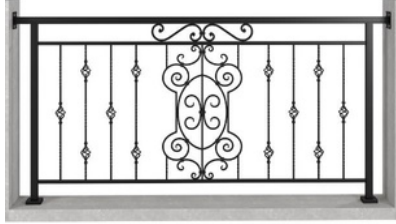

P6LC06

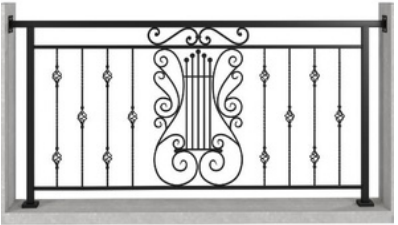

P6LC07

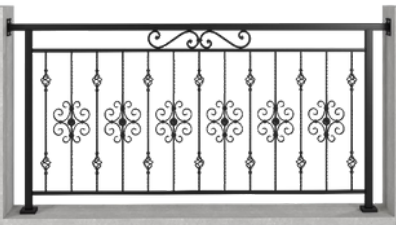

P6LC08



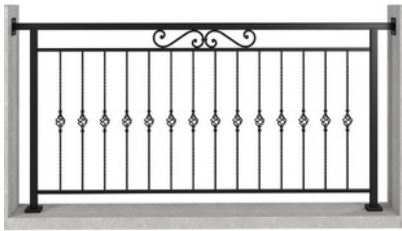

P6LC09

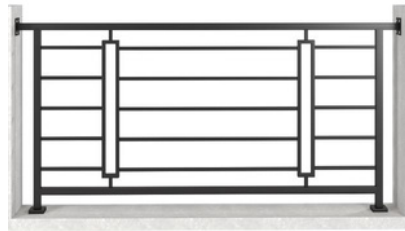

P6LC10

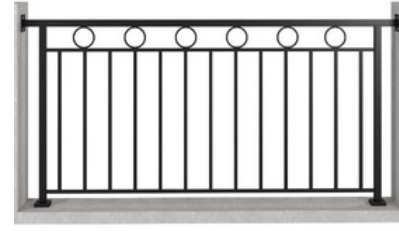

P6LC13

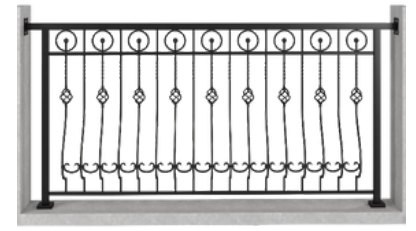

P6LC14

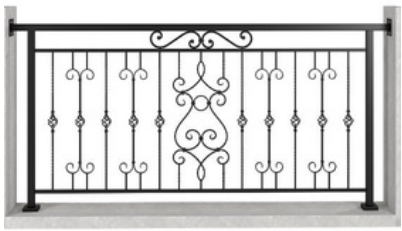

P6LC11



P6LC12

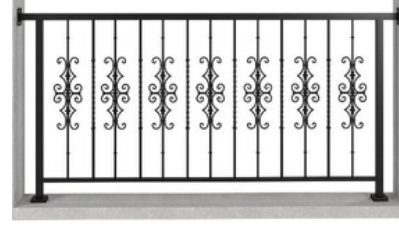

P6LC15



P6LC16

## STEEL FENCE

**Material:** Steel Surface treatment process with 4 protective layers:

- Galvanize:** Using pre-galvanize materials that help protect the products from oxidation.
- Phosphate conversion coating** helps improve corrosion resistance, enhance appearance, promote adherence.
- Primer coating:** Priming is a key to double protection of products.
- Finishing coating:** high -quality, lead-free powder coat and UV resistance in compliance with American Standard TC AAMA 2603



P6LC17

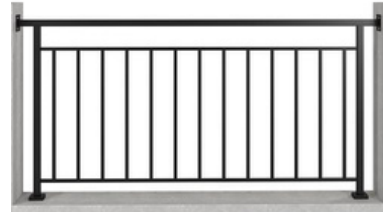

P6LC18

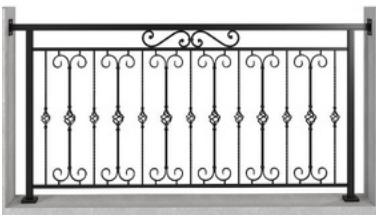

P6LC19

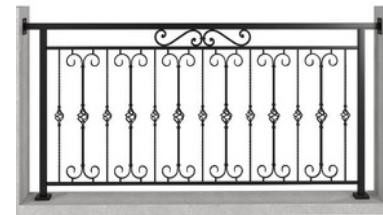

P6LC20

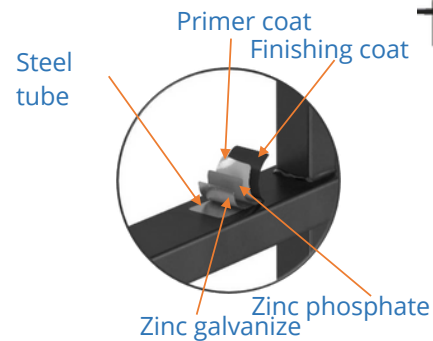
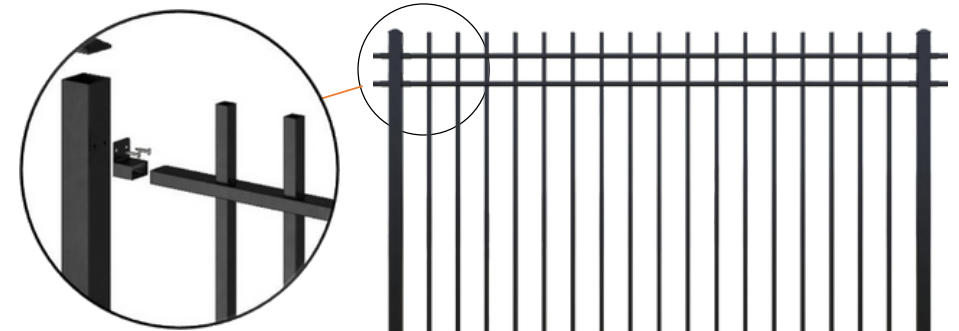



## Gates and Hardware

**Description:** The quality and design of our gates can fit any residential or commercial application. Available in all standard styles with custom designs available.

**Surface treatment:** The product is surface treated on a closed, automatic powder coating line with the following surface requirements:

- 10 year limited warranty
- Passing 1500hr neutral salt spray test under ASTM B117 standard
- Multi protective layer: Zinc galvanized, Nanoceramic, Primer coating, Finishing coating
- Lead-free & UV Resistant

**Available Specifications:**

- **Panel:** 4' - 20' width, 48in -96in height
- **Picket:** 1/2" - 1", 14GA-20GA
- **Rail:** 1" - 2", 12GA-18GA
- **Post:** 2"x2 - 4"x4", 12GA-18GA; 5' - 12' height
- **Fence head:** Flat, formed tube, detachable spearhead, or complex
- **Custom Specifications available for project specific needs**



Circle post



Square post



Square post with steel plate



Circle post with steel plate

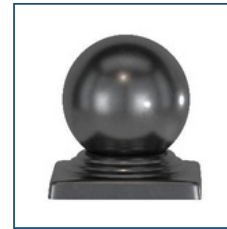

Ball post cap



Square post cap



Hinge



Spearhead



Spearhead



Bracket



Bracket



Bracket



Bracket



# SWING AND SLIDING GATES

## CUSTOM GATE STYLES



DUAL SWING GATE



SINGLE SWING GATE



SLIDING GATE



PEDESTRIAN GATE

## DUAL GATE STRUCTURE

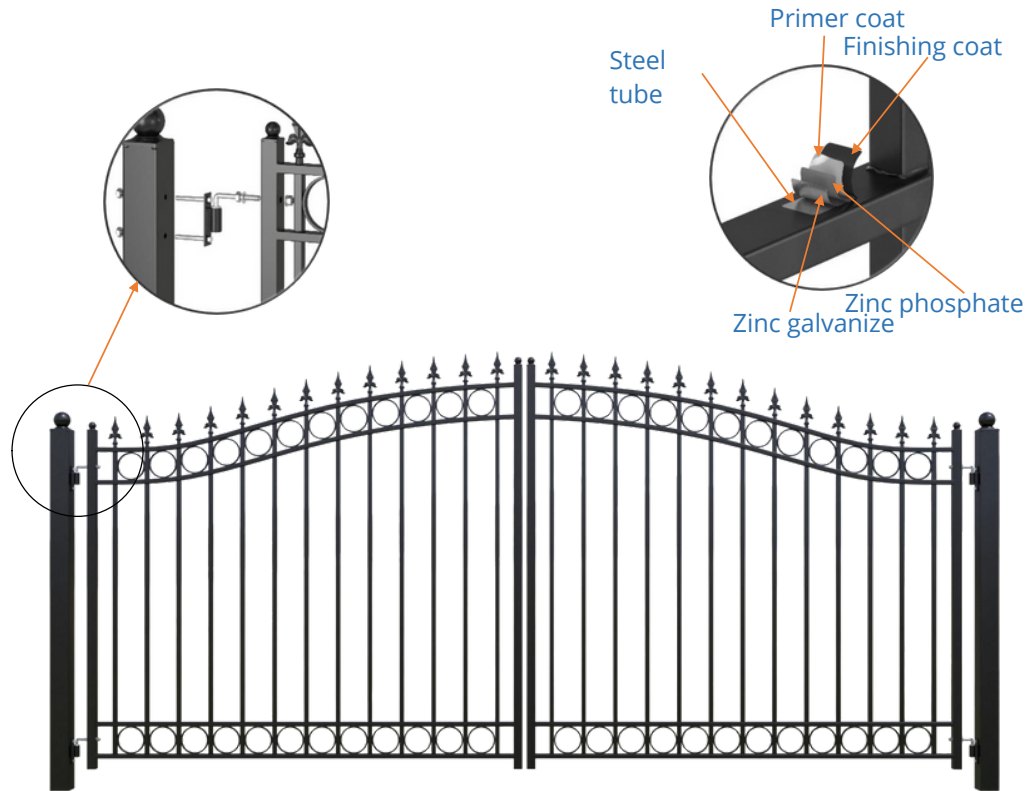

# SINGLE GATE STRUCTURE

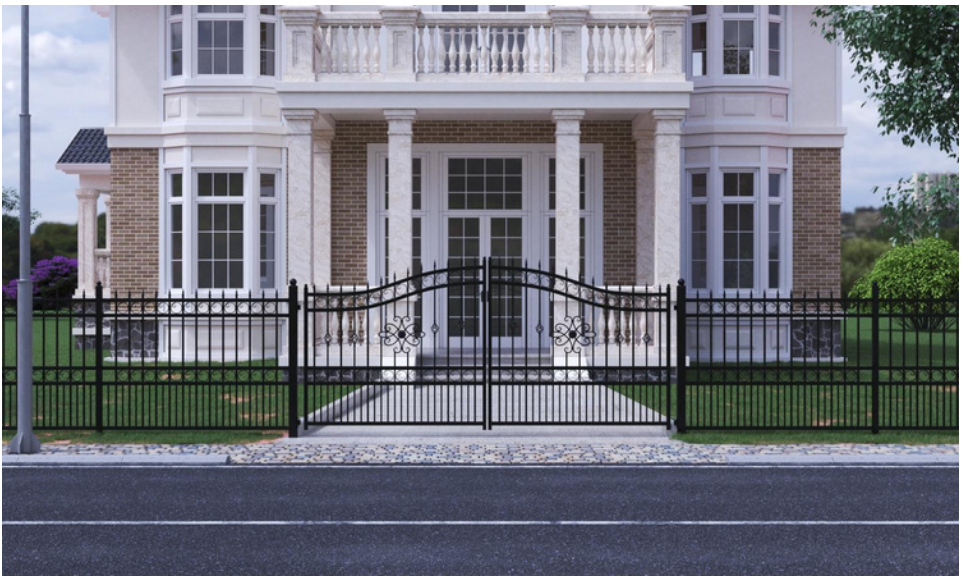
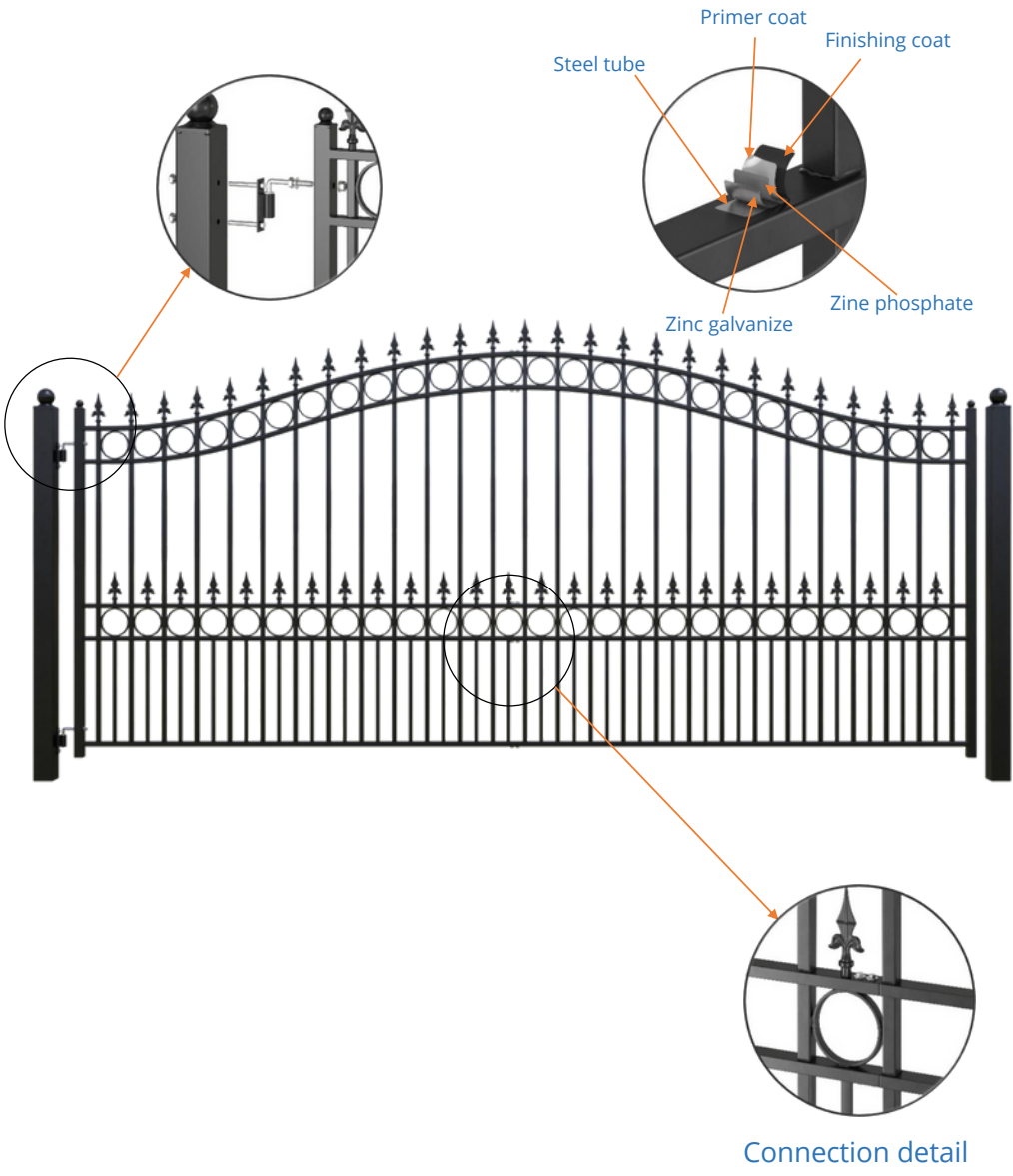



P6SG09



P6SG10



P6SG11



P6SG12



P6SG13



P6SG14



P6SG05



P6SG06



P6SG15



P6SG16



P6SG07



P6SG08

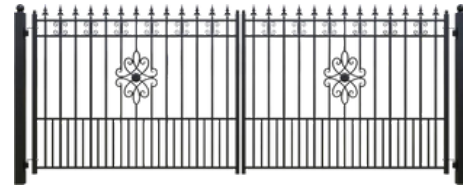

P6SG17



P6SG18



P6SG25

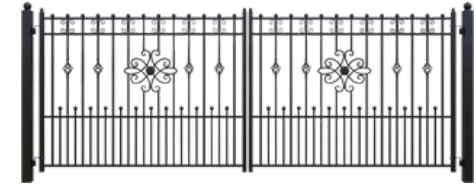

P6SG26



P6SG27



P6SG28



P6SG19



P6SG20



P6SG29



P6SG30



P6SG21



P6SG22



P6SG31



P6SG32



P6SG23



P6SG24



P6SG33

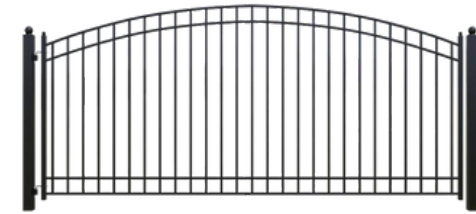

P6SG34

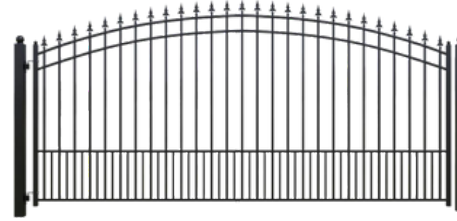

P6SG37

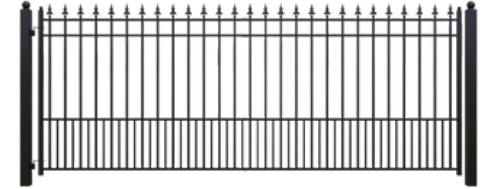

P6SG38



P6SG39



P6SG40

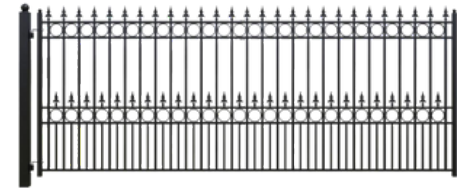

P6SG41



P6SG42

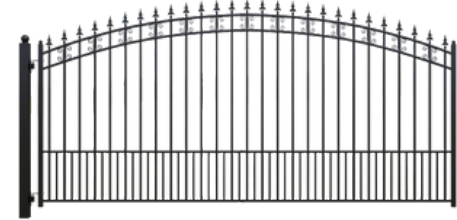

P6SG43

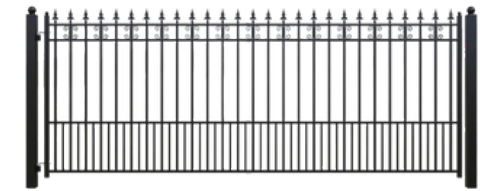

P6SG44

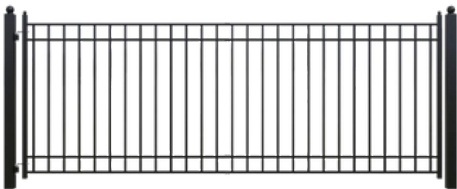

P6SG35

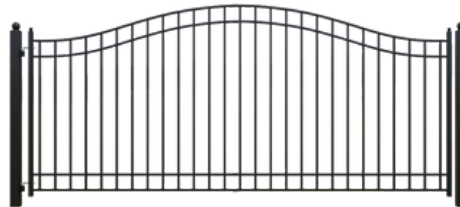

P6SG36



P6SG45

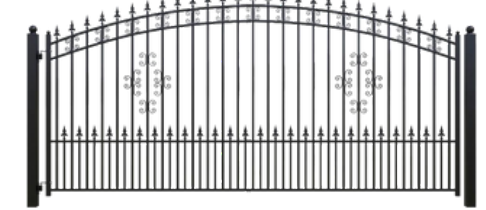

P6SG46

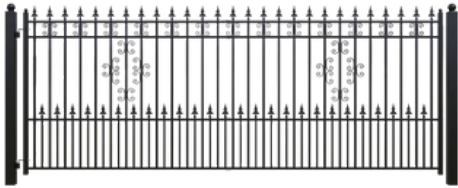

P6SG47



P6SG48

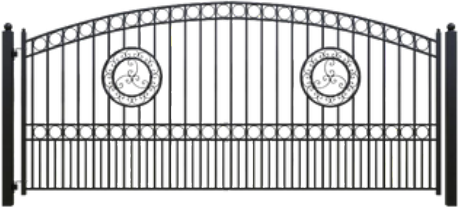

P6SG49

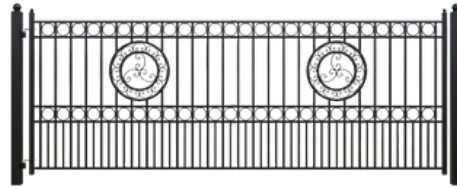

P6SG50

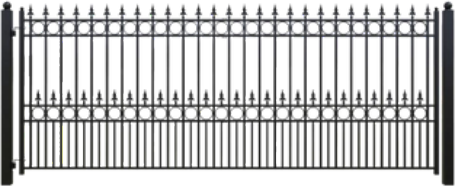

P6SG41

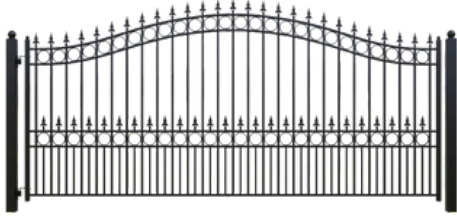

P6SG42



P6SG43

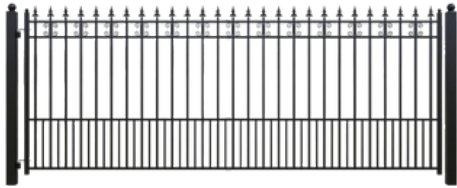

P6SG44

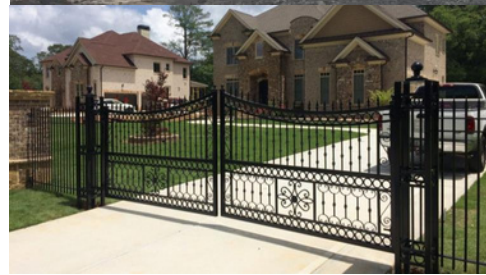

P6SG51



P6SG52



P6SG45



P6SG46

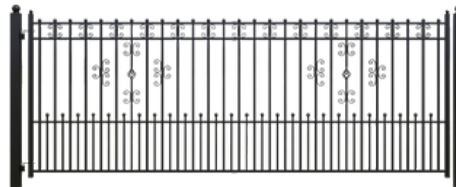

P6SG53

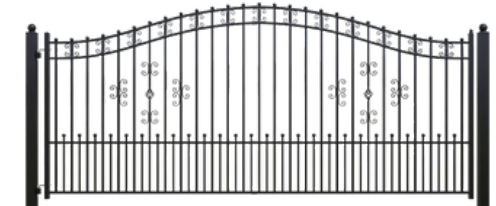

P6SG54



P6SG55



P6SG56



P6SG57



P6SG58



P6SG59



P6SG60



P6SG61



P6SG62



P6SG63



P6SG64



P6SG65



P6SG66



P6SG67



P6SG68



P6SG69



P6SG70



P6SG71



P6SG72



P6SG73



P6SG74

